

Frosta

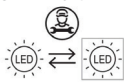

220-240V, 50/60Hz

2: Replaceable (LED only) light source by a professional



3: Replaceable control gear by a professional



NO: Kan kun installeres og vedlikeholdes av en registrert installasjonsvirksomhet.
DK: Må kun installeres og vedlikeholdes af uddannet elektriker.
SE: Skall installeras och underhållas av behörig elektriker.
EN: Only to be installed and maintained by an authorized electrician.
FR: Doit être installé et maintenu par un électricien qualifié.
NL: Mag alleen geïnstalleerd en onderhouden worden door een bevoegde electricien.
DE: Dieses Produkt darf nur durch autorisiertes Personal (z.B. Elektro-Installateur) angeschlossen, in Betrieb genommen und gewartet werden.
FI: Asentaa ja huolttaa saa vain valtuutettu sähköasentaja

NO: Skru av strømmen før montering.
DK: Sluk for strømmen inden montering.
SE: Stäng av strømmen innan montering.
EN: Turn off power before installing.
FR: Couper le courant avant l'installation.
NL: Stroom uitschakelen voor u het toestel installeert.
DE: Vor Installationsarbeiten den Strom abschalten.
FI: Sammuta virta ennen kytkestä

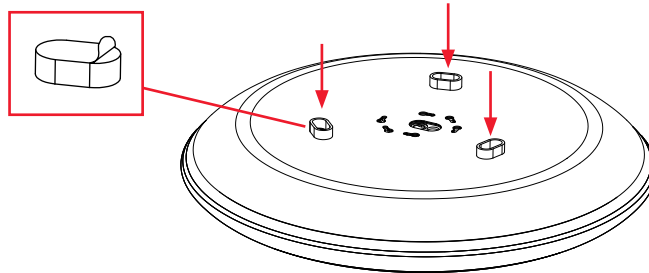
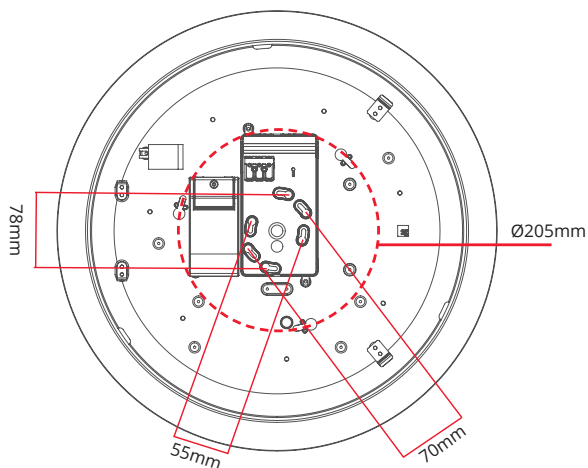
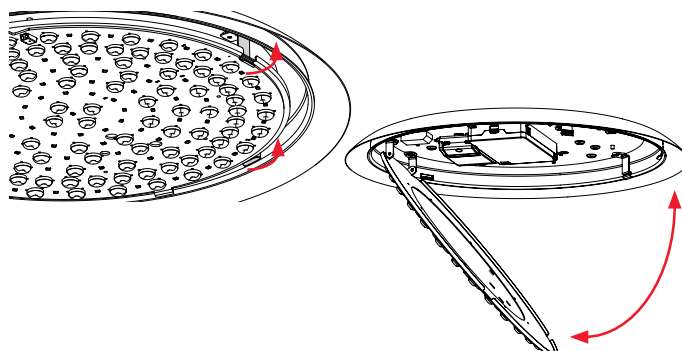
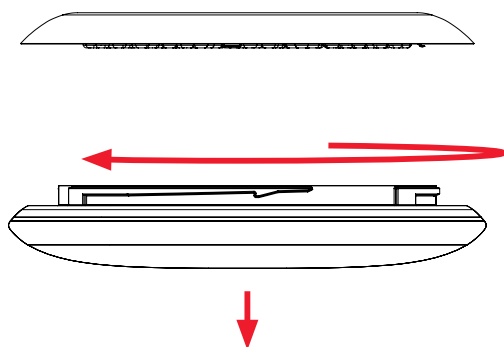
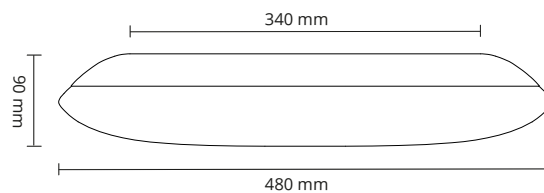
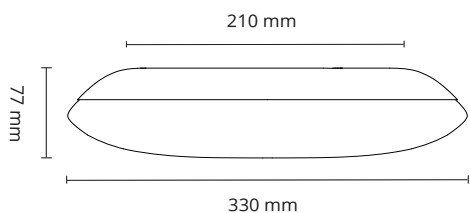

NORWAY
SG Armaturen AS
 Skytterheia 25
 N-4790 Lillesand

SWEDEN
SG Armaturen AB
 Tel: +46 31 81 71 10
 info@sg-ab.se
 www.sg-ab.se

DENMARK
SG Armaturen A/S
 Tel: +45 70 70 72 13
 info@sg-as.dk
 www.sg-as.dk

FRANCE
SG Lighting SA/NV
 Tel: +33(0) 4 94 93 00 00
 info.france@sglighting.fr
 www.sglighting.net

GERMANY
SG Leuchten GmbH
 Tel: +49 40 23 99 44 59
 info@sg-leuchten.de
 www.sg-leuchten.de

Tel: +47 37 50 03 00
 firmapost@sg-as.no
 www.sg-as.no

FINLAND
SG Armaturen Oy
 Tel: +358 02 07 30 39 60
 info@sg-oy.fi
 www.sg-oy.fi

UNITED KINGDOM
SG Lighting LTD
 Tel: +47 37 50 03 00
 info@sglighting.co.uk
 www.sglighting.co.uk

BENELUX
SG Lighting SA/NV
 Tel: +32(0) 15 20 72 71
 info.benelux@sglighting.net
 www.sglighting.net

INTERNATIONAL
SG Lighting Co Ltd.
 Tel: +86 769 88 49 20 88
 cindy@sgdgc.com
 www.sg-as.com

Rev:12.06.2023

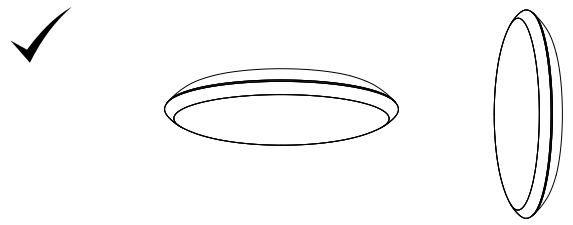
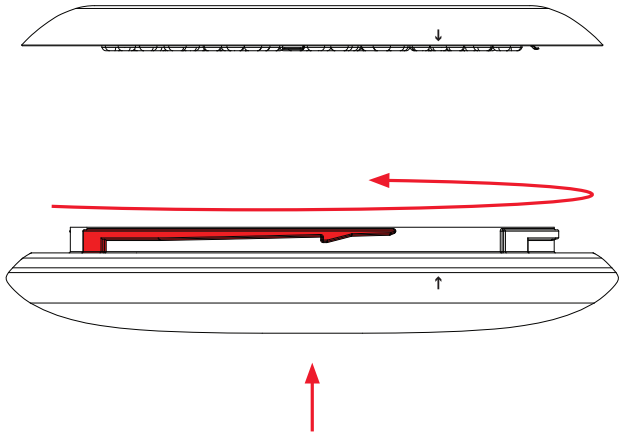
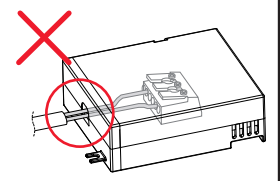
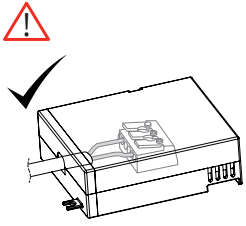
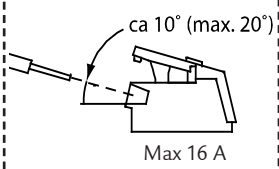
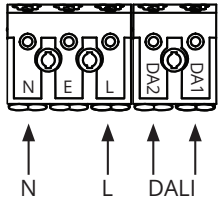

Dipswitch

Frosta 480

Frosta 330

	mA	lm		mA	lm
	250	39%		125	28%
	280	44%		150	33%
	310	48%		175	39%
	340	53%		200	44%
	370	58%		225	50%
	400	63%		250	56%
	430	67%		275	61%
	460	72%		300	67%
	490	77%		325	72%
	520	81%		350	78%
	550	86%		375	83%
	580	91%		400	89%
	610	95%		425	94%
	640	100%	Standard	450	100%
	670			475	
	700		500		

Dali Dim

Push Dim

